

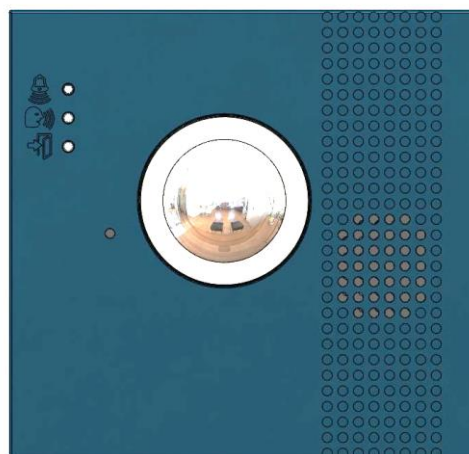

32 - 0003



DITA CREATE "MODULE CAMERA"

MODULAR INTERCOM "CAMERA MODULE"

DITA CREATE "KAMERA-MODUL"

DINA CREATE "CAMERAMODULE"

MODULAR INTERCOM "CAMERA MODULE"



AUDIO CALL / APPEL AUDIO / AUDIO-ANRUF / AUDIO CALL / LLAMADA DE AUDIO

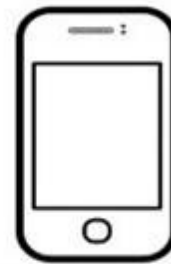

4G IP Module
17 - 0233
17 - 0263

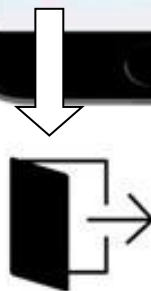

VIDEO CALL / APPEL VIDEO / VIDEO-ANRUF / VIDEO CALL / VIDEO LLAMADA



4G IP Module
17 - 0233
17 - 0263

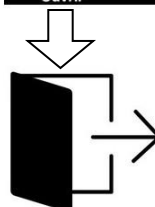
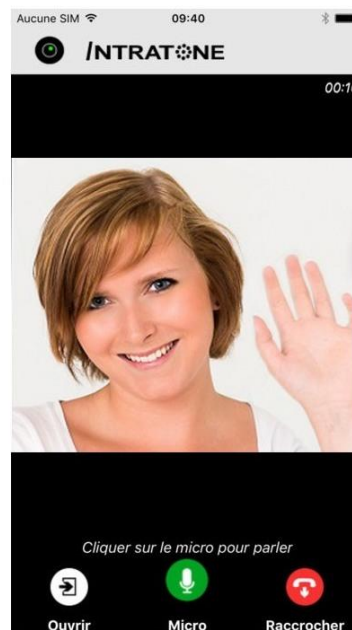
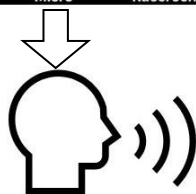

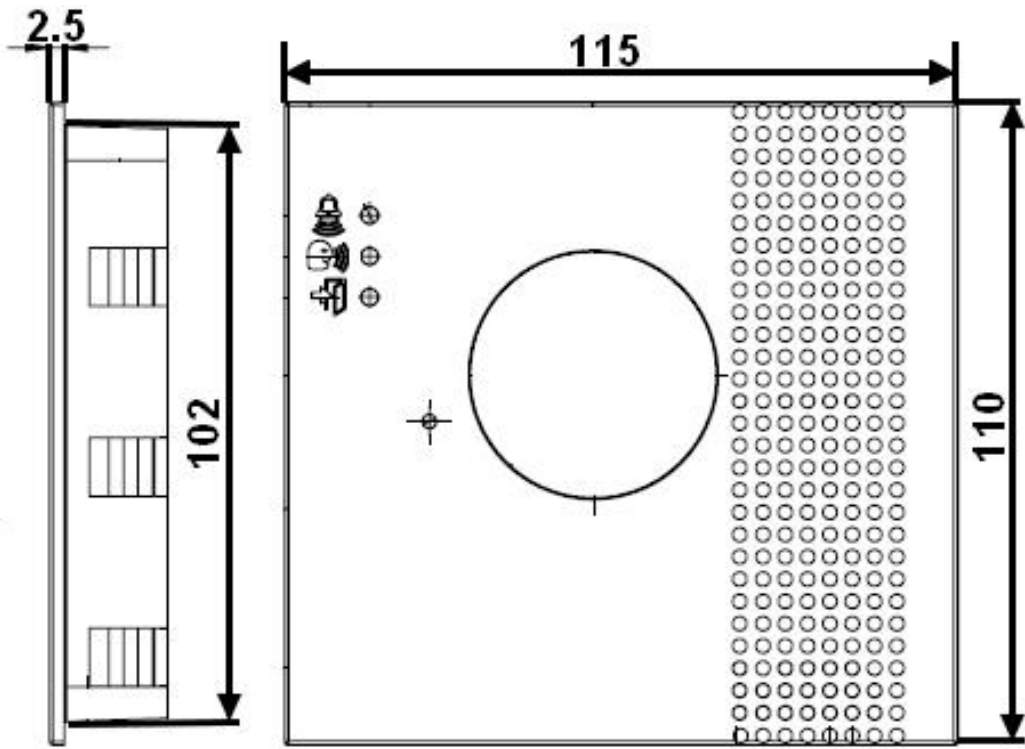

Percer le support
Drill the support
Bohren Sie die Löcher für den Befestigungsrahmen
Boor de steun
Bor støtte

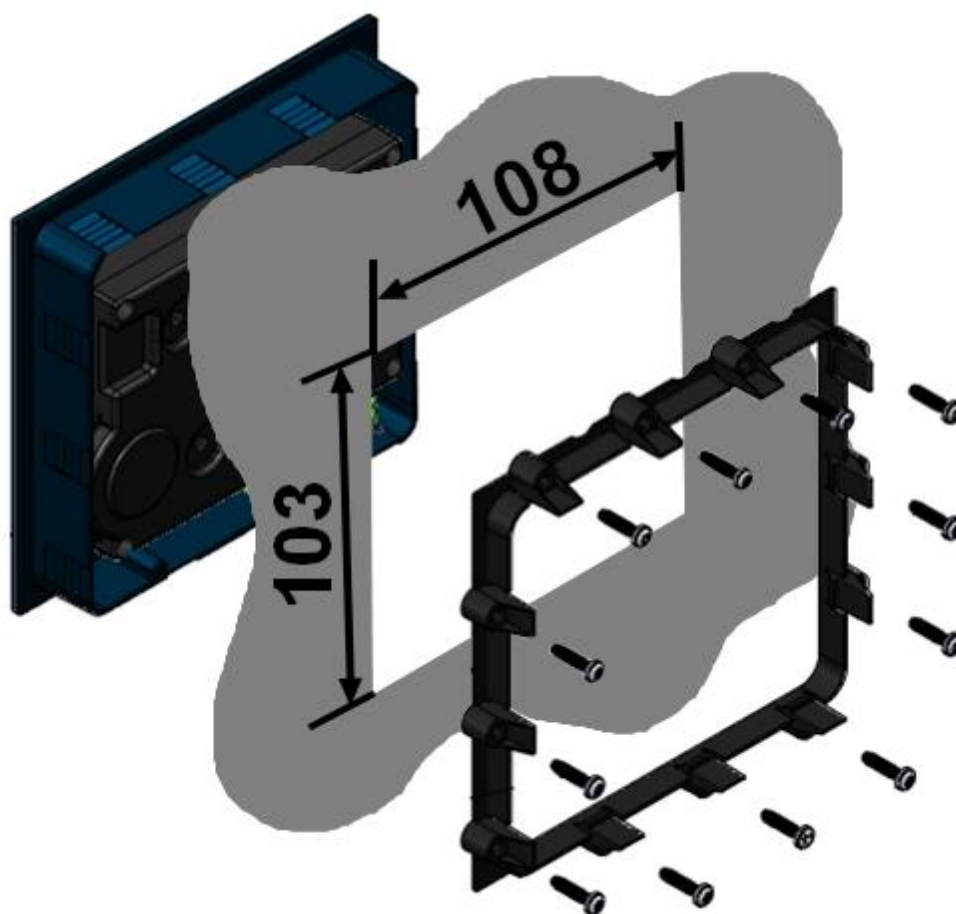

Support : Epaisseur 8 mm maximum.
Enfoncez le support arrière au maximum puis ajuster le serrage avec les vis.
Vérifiez que tous les crans du cadre soient bien en place.

Support: Thickness 8 mm maximum.
Push the rear support in as far as possible, then adjust the tightening with the screws.
Check that all notches in the frame are in place.

Befestigungsrahmen: Max. Dicke der Montagefläche – mit dem im Lieferumfang enthaltenen Schrauben - 8mm. Drücken Sie die hintere Stütze so weit wie möglich hinein und stellen Sie das Anziehen mit den Schrauben ein.

Ondersteuning: dikte 8 mm maximal.
Duw de achterste steun zo ver mogelijk naar binnen en pas vervolgens de aanscherping aan met de schroeven.

Controleer of alle inkepingen in het frame op hun plaats zitten.

Støtte: Tykkelse 8 mm maks.
Skub bagestøtten ind så langt som muligt, og juster derefter spændingen med skruerne.
Kontroller, at alle hak i rammen er på plads

Space between two modules (example):
Abstand zwischen zwei Modulen (Beispiel):
Ruimte tussen twee modules (voorbeeld):
Mellemrum mellem to moduler (eksempel):

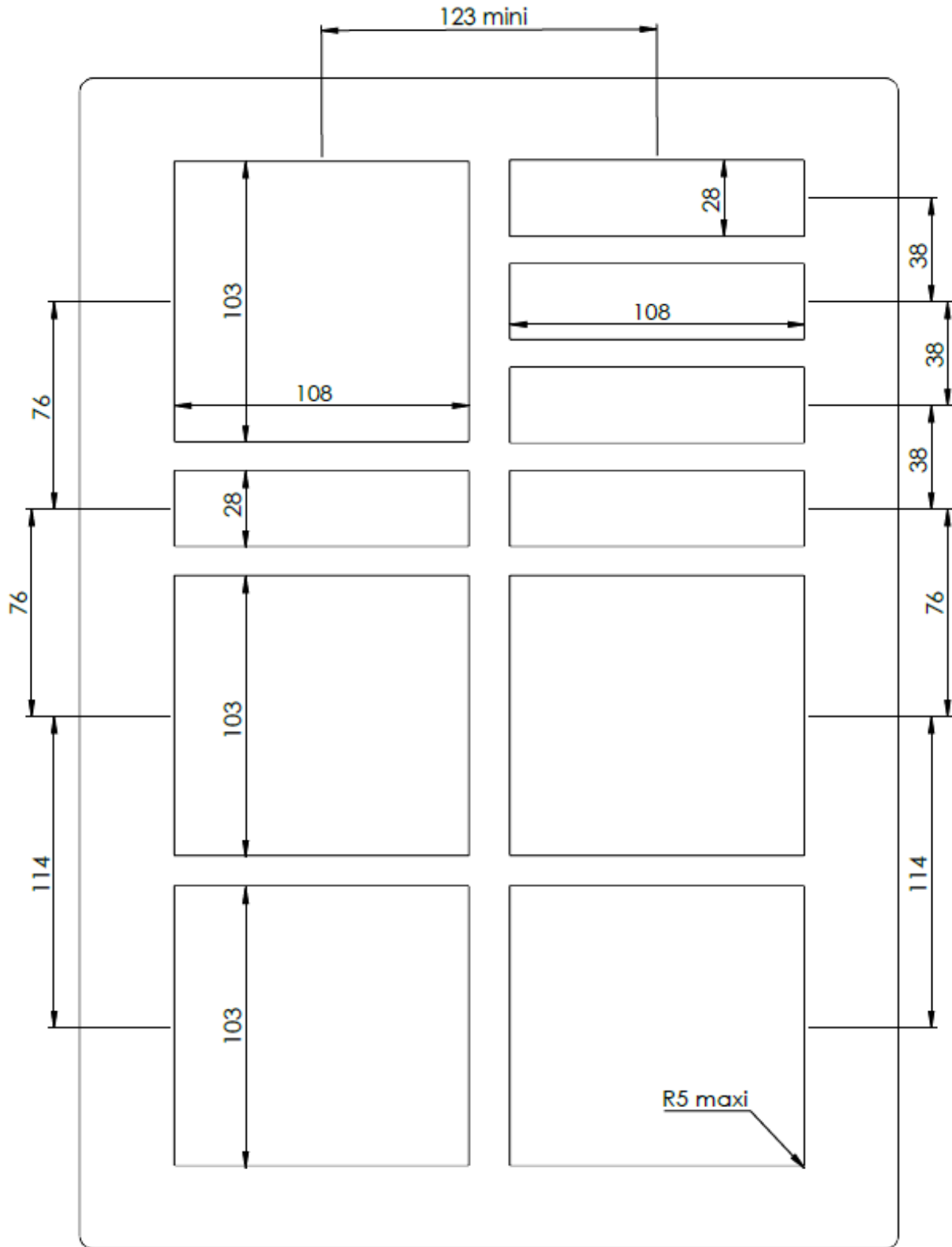

Raccordement des différents éléments :
Connection of the different éléments :
Verbindung der verschiedenen Elemente :
Verbinding van de verschillende elementen :
Forbindelse mellem de forskellige elementer :

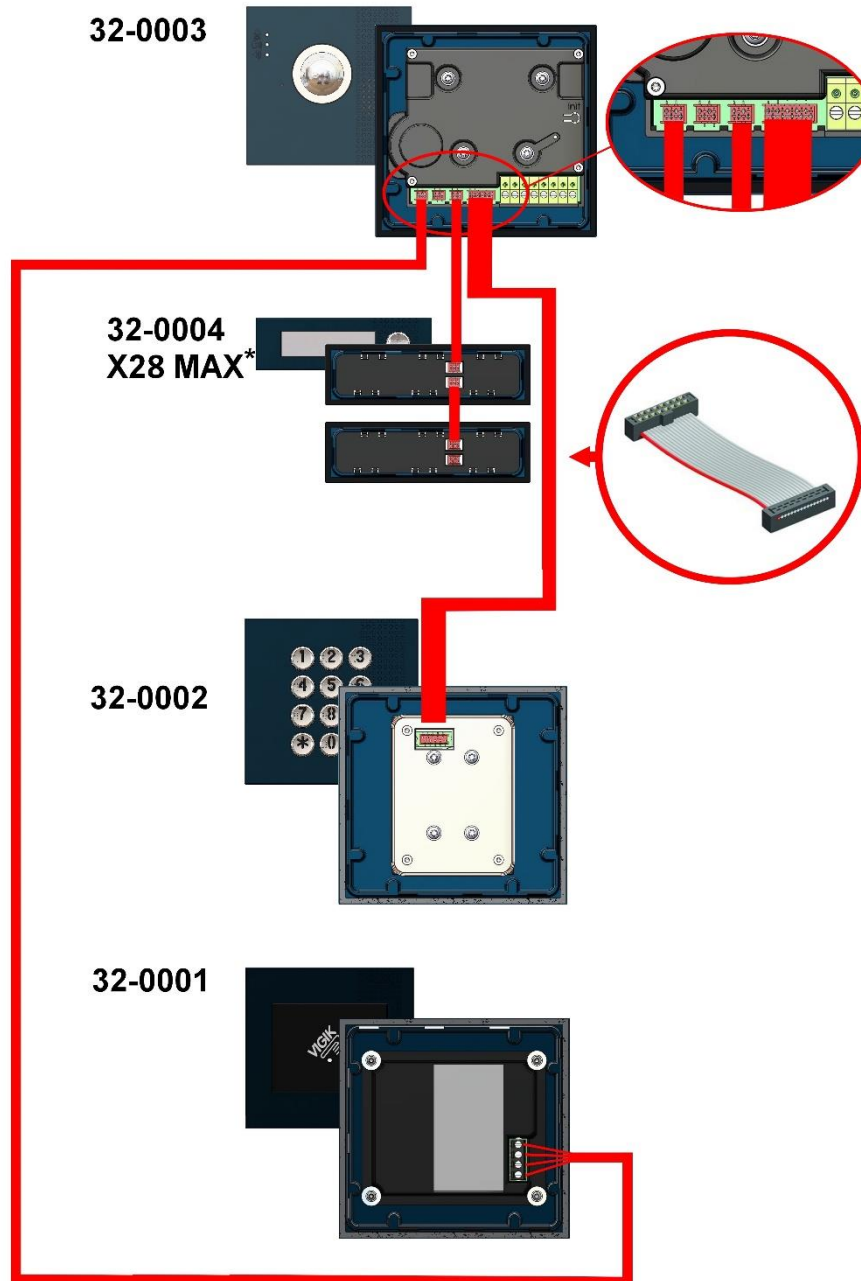

*Pour la pose d'un nombre d'étiquette (32-0004) supérieur à 28, utilisez un Répéteur (32-1002).

*For laying a label number (32-0004) greater than 28, use a Repeater (32-1002).

*Verwenden Sie zum Verlegen einer Etikettennummer (32-0004) größer als 28 einen Repeater (32-1002).

*Gebruik een repeater (32-1002) om een labelnummer (32-0004) groter dan 28 te leggen.

*Brug en Repeater (32-1002) til at lægge et etiketnummer (32-0004) større end 28.



03-0102

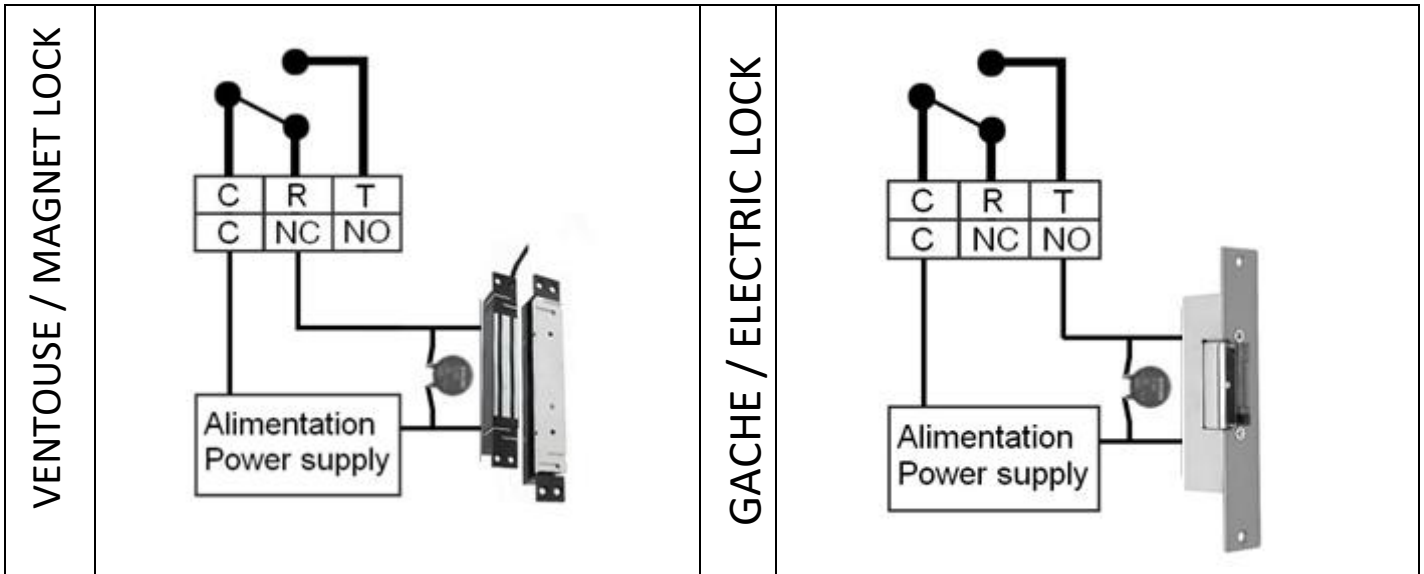
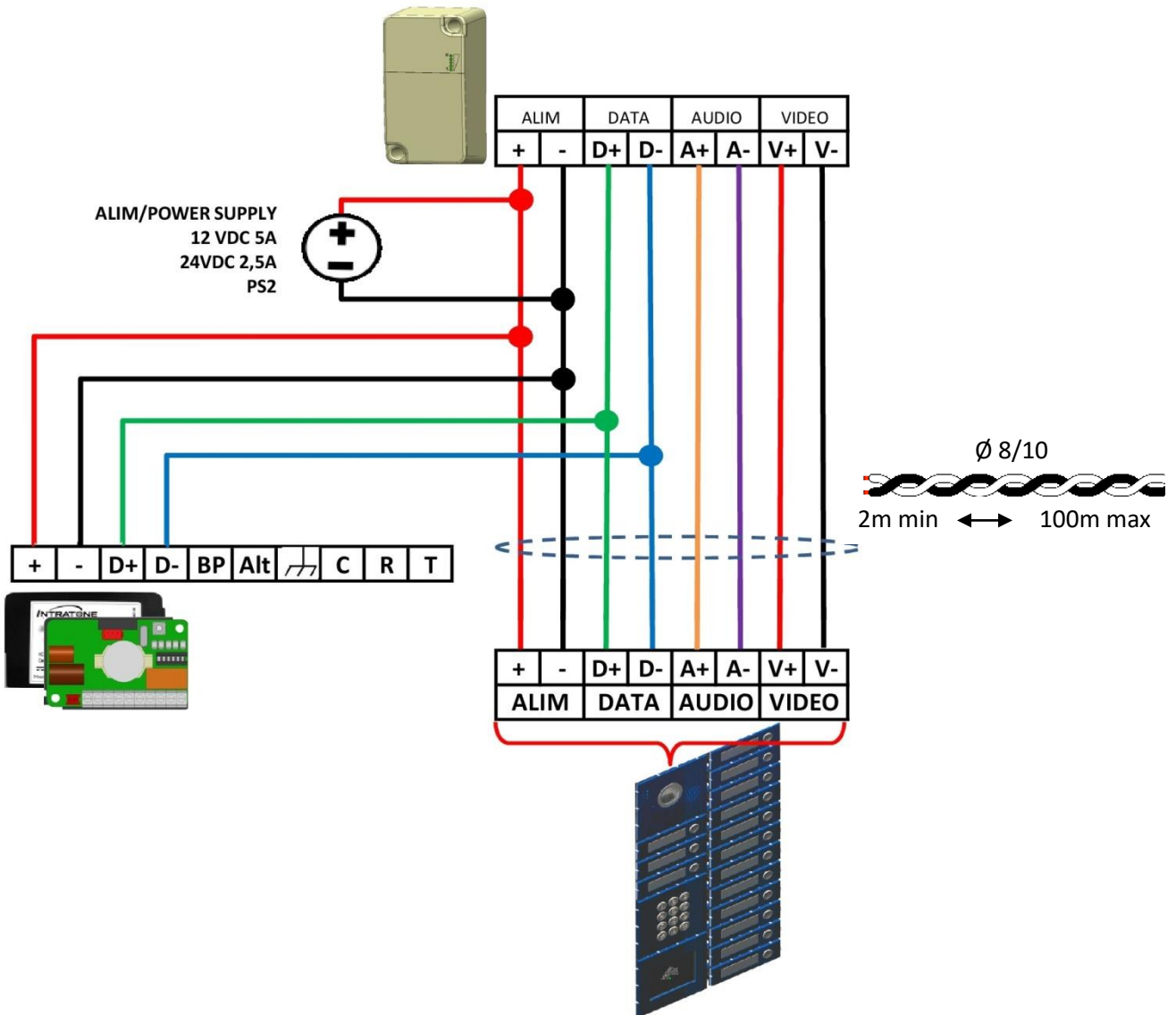

03-0101



ALIM/POWER SUPPLY
12 VDC 5A
24VDC 2,5A
PS2

ALIM		DATA		AUDIO		VIDEO	
+	-	D+	D-	A+	A-	V+	V-

ALIM		DATA		AUDIO		VIDEO	
+	-	D+	D-	A+	A-	V+	V-

+	-	11	12	13	14	15	16						
Alim/PS	+	-	D+	D-	A+	A-							

21	22	23	24	25	26	27	28	29	C	R	T
+	-	D+	D-	A+	A-	BP	Alt	C	NC	NO	

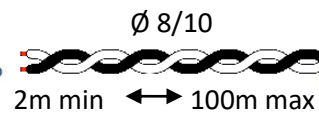

VENTOUSE / MAGNET LOCK

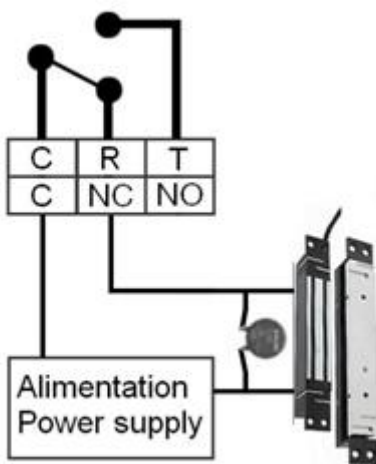

GACHE / ELECTRIC LOCK

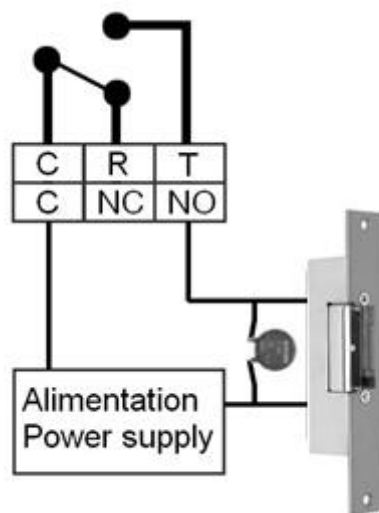

Numérotation des boutons :

Il faut définir le N° de chaque étiquette, ce numéro vous sera utile dans le site de gestion www.intratone.info
A l'arrière du module caméra, il y a une touche « Init ». Appuyez dessus pendant 10 secondes.
Tous les écrans vont afficher « ??? ». Appuyez sur les touches des étiquettes dans l'ordre souhaité de la première à la dernière.
30 secondes d'inactivités ferment la configuration.

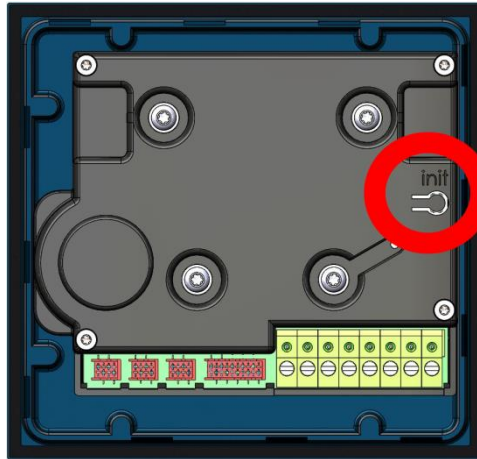

Numbering of the buttons:

We must define the number of each label, this number will be useful in the management site www.intratone.info
At the back of the camera module, there is an "Init" button. Press it for 10 seconds.
All screens will show "???" ". Press the label keys in the desired order from first to last.
30 seconds of inactivity close the configuration.

Nummerierung der Tasten:

Wir müssen die Nummer jedes Klingelschilds definieren. Diese Nummer wird die Zuordnung auf der Verwaltungswebsite www.intratone.info vereinfachen.
Auf der Rückseite des Kameramoduls befindet sich eine "Init" -Taste. Drücken Sie die Taste 10 Sekunden lang.
Alle Bildschirme zeigen "???" ". Drücken Sie die Etikettentasten in der gewünschten Reihenfolge von Anfang bis Ende.
30 Sekunden Inaktivität schließen die Konfiguration ab.

Nummering van de knoppen:

We moeten het nummer van elk label definiëren, dit nummer zal handig zijn op de beheersite www.intratone.info
Aan de achterkant van de cameramodule bevindt zich een knop "Init". Druk voor 10 seconden op het.
Alle schermen laten zien "???" ". Druk op de etikettoetsen in de gewenste volgorde van het begin tot het einde.
30 seconden inactiviteit sluit de configuratie.

Nummerering af knapperne:

Vi skal definere nummeret på hver etiket, dette nummer vil være nyttigt på ledelsesstedet www.intratone.info
På bagsiden af kameraet er der en "Init" -knap. Tryk på den i 10 sekunder.
Alle skærme vil vise "???" ". Tryk på etiketasterne i den ønskede rækkefølge fra første til sidste.
30 sekunder inaktivitet lukker konfigurationen.



1

Allez dans  et créer votre résidence



2

Cliquer "Créer", choisir l'interphone « Dita Create » ref 32-0003

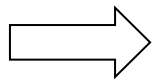

Interphone Dita Create

3

Personnaliser le design de votre Dita Create en utilisant l'interface.

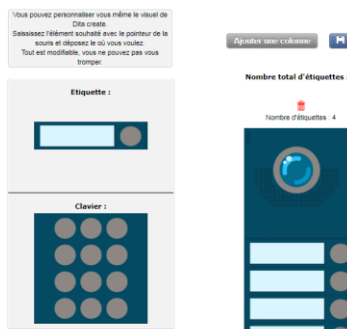

4

Cliquer "Configurer la centrale" et remplir les champs.

Configurer la centrale

5

Utilisez le bouton « .
Répéter l'opération pour toutes les étiquettes

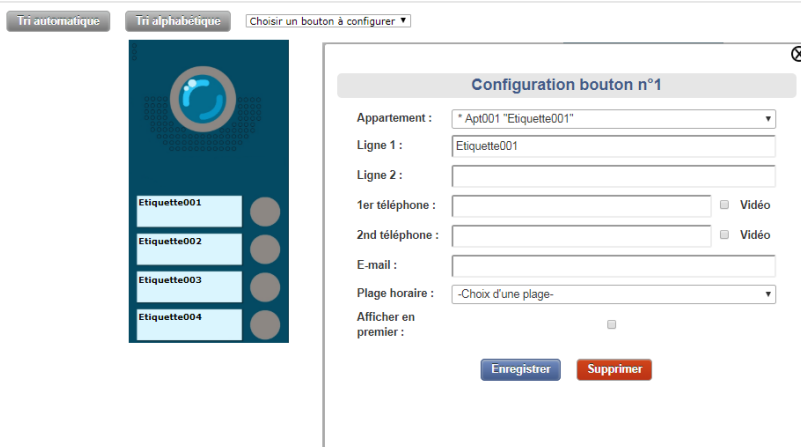

6

Mettre à jour la résidence

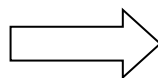

Mettre à Jour



1

Go to the residence



2

Click "Create" ,choose your intercom and name it

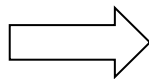

Dita Create intercom

3

Now let's configure the digital labels :

You can personalise your Dita Create graphic yourself.
Grab the desired element using the mouse pointer and move it wherever you like. Everything is editable, you won't make a mistake.

Add column Save

Total number of labels : 4

Label no. : 4

Name :

Keyboard :

4

Now you need to "Central unit settings "



5

Choose the button to configure and fill in the fields.

Repeat for all digital labels.

Automatic filtering Alphabetic filtering Choose a button to configure

Setup button 1

Apartment : Apt001 "Etiquette001"

1st row : Etiquette001

2nd row :

1st number called : Video

2nd number called : Video

E-mail :

Time range : -Choose a time range-

Show always

6

Update the residence

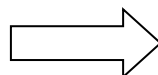



1

Gehen Sie zu „Wohnanlagen“



2

Klicken Sie auf "Erstellen" und wählen Sie Ihre Gegensprechanlage aus. Benennen Sie diese.

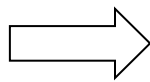

Dita Create Gegensprechanlage

3

Jetzt können Sie die digitalen Etiketten konfigurieren:



4

Jetzt müssen Sie auf "konfigurieren der Zentrale" klicken.

Konfigurieren der Zentrale

5

Wählen Sie die Schaltfläche zum Konfigurieren und füllen Sie die Felder aus.

Wiederholen Sie dies für alle Etiketten



6

Wenn Sie fertig sind, vergessen Sie nicht Ihre Wohnanlagen zu „aktualisieren“.

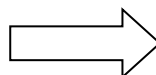

Aktualisieren



1

Ga naar de woning



2

Klik op "Maken" kies uw Video-intercom en noem het

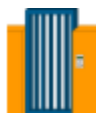
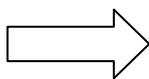

Intercom Dita Create

3

Laten we nu de digitale labels configureren:

U kunt zelf het beeld van uw Dita Create personaliseren. Klik op het item dat u wilt verplaatsen en sleep deze naar de gewenste plek. Alles kan aangepast worden, u kunt zich niet vergissen.

Kolom toevoegen Registreren

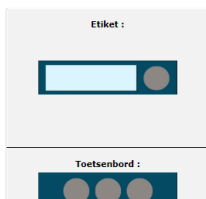

Totaal aantal labels : 4



4

Nu moet u "De centrale configureren"

Ahora necesitas "Configurar la central"

De centrale configureren

5

Kies de knop om te configureren en vul de velden in. Herhaal dit voor alle labels.

Automatisch sorteren Alfabetisch sorteren Kies een knop om te configureren

Configuratie knop nr.1

Appartement : * Apt001 "Etiquette001"

Regel 1 : Etiquette001

Regel 2 :

1e telefoon : Video

2e telefoon : Video

E-mail :

Tijdsbereik : -Keuze van een bereik-

Als eerste weergeven :

6

Voordat u vertrekt, moet u de accommodatie altijd bijwerken

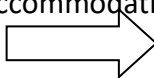



1

Ga naar de woning



2

Klik op "Maken" kies uw Video-intercom en noem het



Dita Create intercom

3

Laten we nu de digitale labels configureren:

You can personalise your Dita Create graphic yourself.
Grab the desired element using the mouse pointer and move it wherever you like.
Everything is editable, you won't make a mistake.

Add column Save

Total number of labels : 4

Label no. : 4

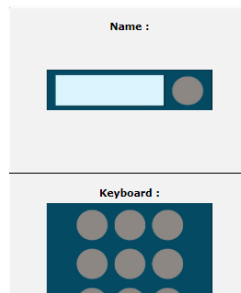

4

Nu moet u "De centrale configureren"

De centrale configureren

5

Kies de knop om te configureren en vul de velden in. Herhaal dit voor alle labels.

Automatic filtering Alphabetic filtering Choose a button to configure ▼

Setup button 1

Apartment : * Apt001 "Etiquette001" ▼

1st row : Etiquette001

2nd row :

1st number called : Video

2nd number called : Video

E-mail :

Time range : -Choose a time range- ▼

Show always first :

6

Voordat u vertrekt, moet u de actie altijd bijwerken

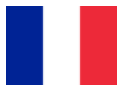

**Garanties de fonctionnement:**

L'Interphone à boutons est garanti dans une plage de température comprise entre -20°C et +60°C et pour une humidité relative maximum de 70%.

Doit être posé selon le sens Haut / Bas préconisé sur l'appareil.

L'installation doit être réalisée par du personnel qualifié possédant les connaissances nécessaires à un montage sûr de l'équipement. Ne pas installer à l'extérieur en cas de températures extrêmes (Finlande, Suède, Norvège).

Ce kit comprend les éléments nécessaires pour assurer une installation sûre de l'équipement.

**Recyclage du produit en fin de vie:**

L'Interphone à boutons et ses accessoires ne doivent pas être mis au rebut avec les déchets municipaux non triés, mais doivent suivre la filière de collecte et de recyclage des produits DEEE (Déchets d'Equipements Electriques et Electroniques).

**Déclaration de conformité simplifiée**

Le soussigné, COGELEC, déclare que l'équipement radioélectrique du type contrôle d'accès pour l'habitat collectif est conforme à la directive 2014/53/UE (RED). Le texte complet de la déclaration UE de conformité est disponible à l'adresse internet suivante : <http://certificates.intratone.com/>

**Warranty operating guarantees:**

The VIDEO INTERCOM WITH DIGITAL NAME is guaranteed within a temperature range of -20°C and +60°C and at a relative humidity level not exceeding 70%.

It must be installed according to the Top/Bottom directions given in these instructions and on the device.

The installation must be carried out by qualified personnel with the necessary knowledge for a safe assembly of the equipment.

This kit includes the necessary elements to ensure a safe installation of the equipment. Finland, Norway, Sweden : Do not install outside because of extreme temperature.

**End-of-life recycling of the product:**

The VIDEO INTERCOM WITH DIGITAL NAME and its accessories must not be discarded with unsorted municipal waste, but must be disposed of via the WEEE (Waste Electrical and Electronic Equipment) collection and recycling system.

**Simplified declaration of conformity**

The undersigned, COGELEC, declares that access control type radio equipment for collective housing is in compliance with Directive 2014/53 / EU (RED). The full text of the EU declaration of conformity is available at the following internet address: <http://www.intratone.fr/documentation> <http://certificates.intratone.com/>

**Funktionsgarantien:**

Der Betrieb der Video-Gegensprechanlage mit LCD-NamensschilderN ist für eine Temperaturspanne zwischen -20 °C und +60 °C und für eine relative Luftfeuchtigkeit von 70 % gewährleistet. Die

Gegensprechanlage muss nach der hier angegeben Richtung Oben/Unten eingebaut werden. Die Installation muss von qualifiziertem Personal mit den notwendigen Kenntnissen für eine sichere Montage der Ausrüstung durchgeführt werden. Dieses Kit enthält die notwendigen Elemente, um eine sichere Installation des Geräts zu gewährleisten. Nicht

im Freien bei extremen Temperaturen installieren (Finnland, Schweden, Norwegen).

**Entsorgung des ausgedienten Geräts:**

Die Video-Gegensprechanlage mit LCD-NamensschilderN und sein Zubehör dürfen nicht mit unsortiertem Hausmüll entsorgt werden, sondern müssen an Sammel- und Recyclestellen für Elektro- und Elektronikgeräte-Abfall abgegeben werden.

**Vereinfachte Konformitätserklärung**

Der Unterzeichnete, COGELEC, erklärt, dass funkgesteuerte Zugangskontrollgeräte für den kollektiven Wohnungsbau der Richtlinie 2014/53 / EU (RED) entsprechen. Der vollständige Text der EU-Konformitätserklärung ist unter folgender Internetadresse verfügbar: <http://certificates.intratone.com/>

Werkingsgarantie:

Het VIDEOINTERCOM MET DIGITALE NAAM werkt bij temperaturen tussen -20 °C et +60 °C en bij een relatieve vochtigheid van ten hoogste 70%.

Moet gemonteerd worden met de juiste zijden naar boven en onder, zoals aangegeven op het intercom.

De installatie moet worden uitgevoerd door gekwalificeerd personeel met de nodige kennis voor een veilige montage van de apparatuur.

Deze set bevat de nodige elementen om een veilige installatie van de apparatuur te garanderen. Niet buitenshuis installeren bij extreme temperaturen (Finland, Zweden, Noorwegen).



Recycling aan het einde van de levensduur:

Het VIDEOINTERCOM MET DIGITALE NAAM en zijn toebehoren mogen niet als restafval worden afgevoerd, maar moeten ingeleverd worden bij inzamelpunten voor elektrische of elektronische apparatuur.



Vereenvoudigde verklaring van overeenstemming

Ondergetekende, COGELEC, verklaart dat radioapparatuur voor toegangscontrole voor collectieve huisvesting voldoet aan Richtlijn 2014/53 / EU (RED). De volledige tekst van de EU-conformiteitsverklaring is beschikbaar op het volgende internetadres: <http://certificates.intratone.com/>



Driftsgarantier:

Knappeintercom er garanteret i et temperaturområde mellem -20 ° C og + 60 ° C og for en maksimal relativ fugtighed på 70%.

Skal installeres i den retning op / ned, der anbefales på enheden.

Installationen skal udføres af kvalificeret personale med den nødvendige viden til sikker installation af udstyret. Installer ikke udendørs i ekstreme temperaturer (Finland, Sverige, Norge).

Dette sæt inkluderer de nødvendige ting for at sikre sikker installation af udstyret.



Genbrug af produkter ved udgangen af livet:

Knappeintercom og dets tilbehør må ikke kasseres med usorteret kommunalt affald, men skal følge indsamlings- og genvindingsprocessen for WEEE-produkter (affalds elektrisk og elektronisk udstyr).



Forenklet overensstemmelseserklæring

Undertegnede, COGELEC, erklærer, at radioudstyr af adgangskontroltype til kollektive boliger er i overensstemmelse med direktiv 2014/53 / EU (RED). Den fulde tekst til EU-overensstemmelseserklæringen er tilgængelig på følgende internetadresse: <http://certificates.intratone.com/>